

Englischer Zug geschweift

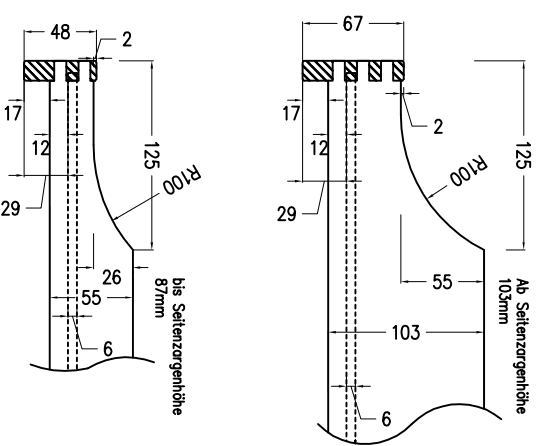

Englischer Zug schräg

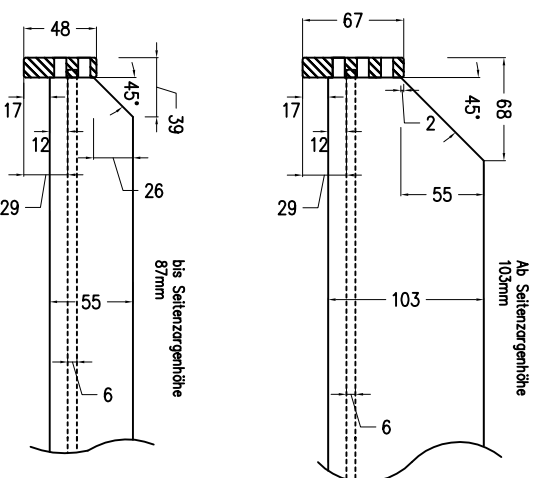

Blendenbohrung

Bohrung variabel nach Ladenhöhe

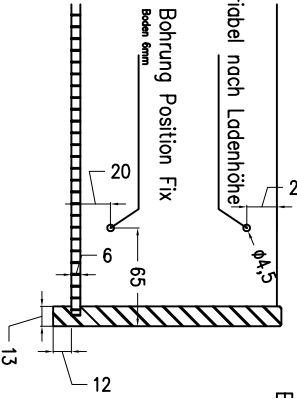

Bohrung variabel nach Ladenhöhe

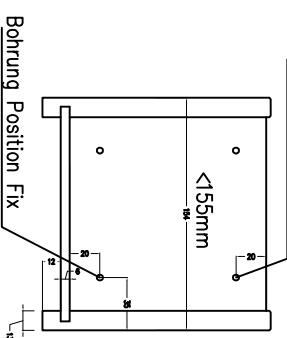

Bohrung variabel nach Ladenhöhe

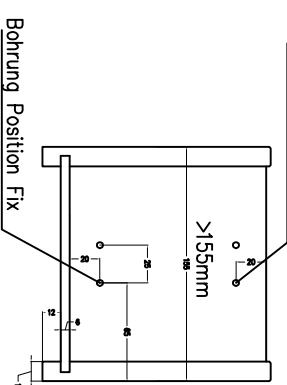

Bohrung variabel nach Ladenhöhe

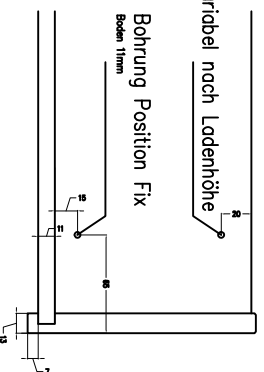

Bohrung variabel nach Ladenhöhe

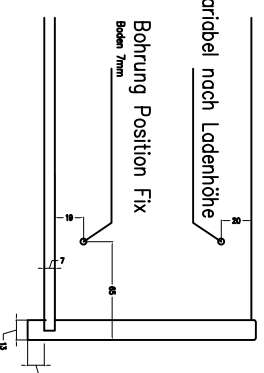

Bohrung variabel nach Ladenhöhe

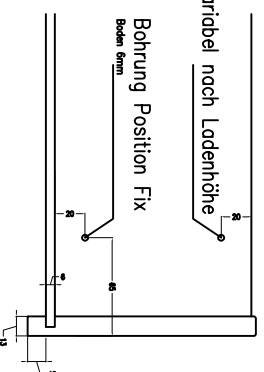

Schütte gebeitz/Ral/roh Boden lose
Boden 3seitig eingenetet

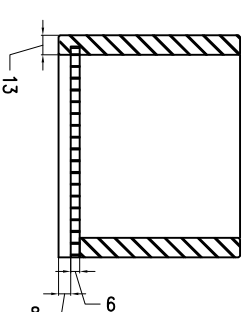

Schütte Boden 4seitig eingenetet

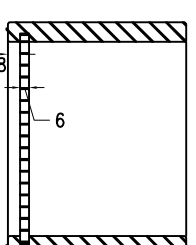

Bohrung BLUM
hinten tiefe 10mm

