

Ohne
Griff-Fräsung

F

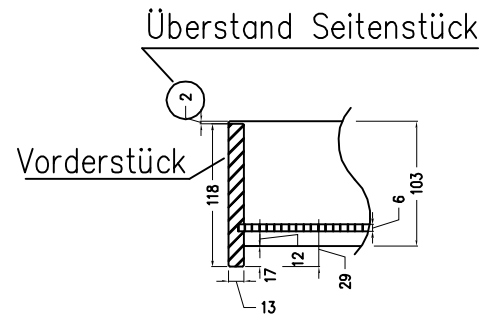
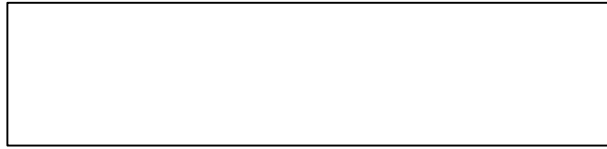

Griff-Fräsung

R

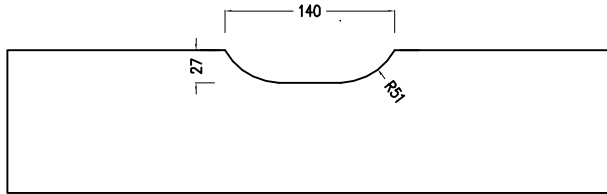

Griff-Fräsung Standard

K

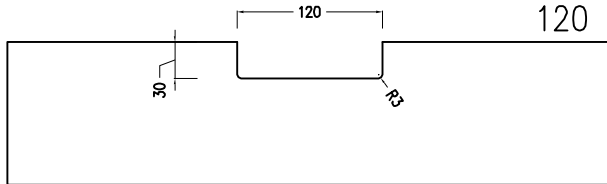

Griff-Fräsung

K

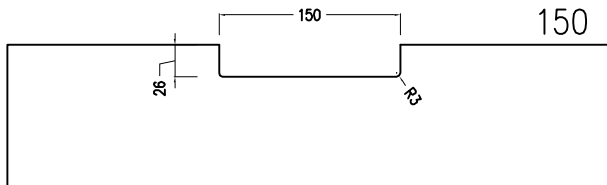

Griff-Fräsung

P

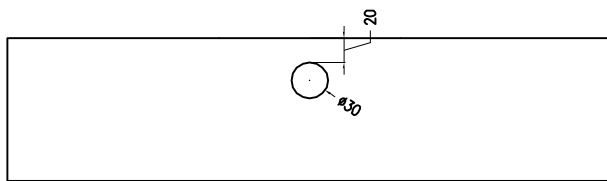

Griff-Fräsung

Q

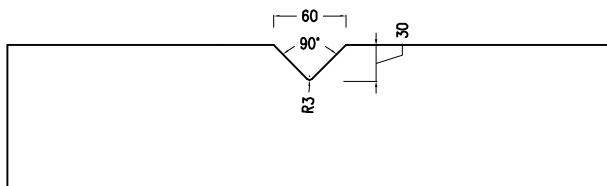

Griff-Fräsung

S

